

Standard Plan A (9m²)

■ Standard Plan A : 9m²
Basic System Panel

Total JPY 73,500 (tax included)

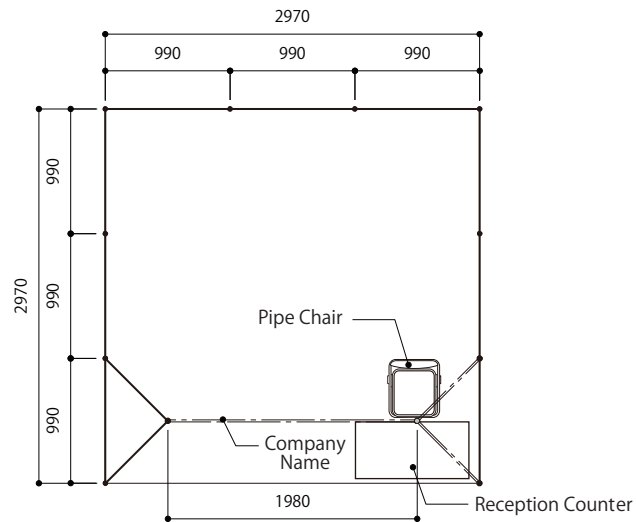

SCALE=1/60

Items	Qty.	Items	Qty.
Carpet	9m ²		
Colored System Panel (W990xH3000)	2		
Parapet (H300)	1set		
Company Name (printed)	1set		
Reception Counter (W900xD450xH800)	1		
Pipe Chair	1		
Primary Electric Construction Fee (utility cost included)	1KW		
Outlet (for 2 plugs)	1		

※You may choose colors for the carpet, system panel and parapet.
Please refer to the Color Sample.

Standard Plan A (18m²)

■ Standard Plan A : 18m²
Basic System Panel

Total JPY 131,250 (tax included)

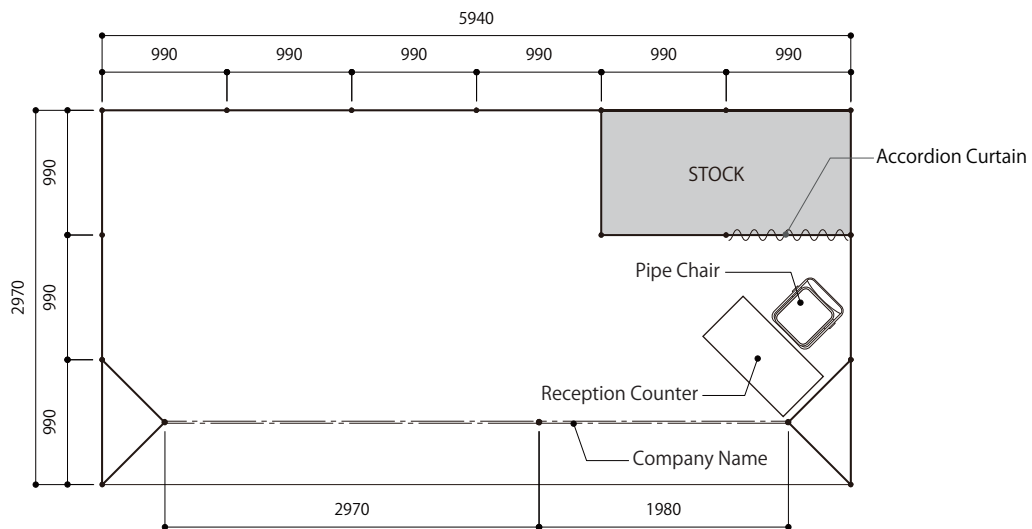

SCALE=1/60

Items	Qty.	Items	Qty.
Carpet	18m ²	Primary Electric Construction Fee (utility cost included)	1Kw
System Panel (W990xH3000)	2	Outlet (for 2 plugs)	1
Colored System Panel (W990xH3000)	4		
Parapet (H300)	1set		
Company Name (printed)	1set		
Accordion Curtain	1set		
Reception Counter (W900xD450xH800)	1		
Pipe Chiar	1		

※You may choose colors for the carpet, system panel and parapet.
Please refer to the Color Sample.

Standard Plan B (9m²)

■ Standard Plan B : 9m²
Basic System Panel

Total JPY 126,000 (tax included)

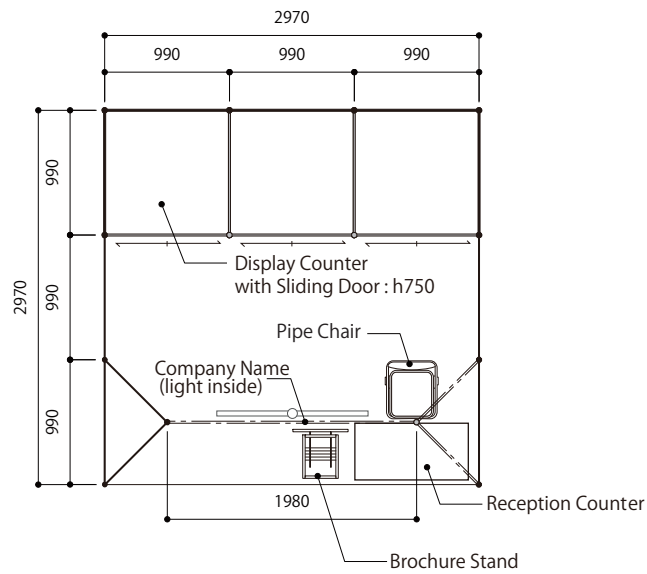

SCALE=1/60

Items	Qty.	Items	Qty.
Carpet	9m ²	Primary Electric Construction Fee (utility cost included)	1Kw
Colored System Panel (W990xH3000)	2	Arm Light	1
Parapet (acrylic) (H300)	1set	Outlet (for 2 plugs)	1
Company Name (with tape)	1set		
Display Counter with Sliding Door (W990xD990xH750)	3		
Reception Counter (W900xD450xH800)	1		
Brochure Stand (A4 Vertical type 12 boxes)	1		
Pipe Chiar	1		

※You may choose colors for the carpet, system panel and parapet.
Please refer to the Color Sample.

Standard Plan B (18m²)

■ Standard Plan B : 18m²
Basic System Panel

Total JPY 199,500 (tax included)

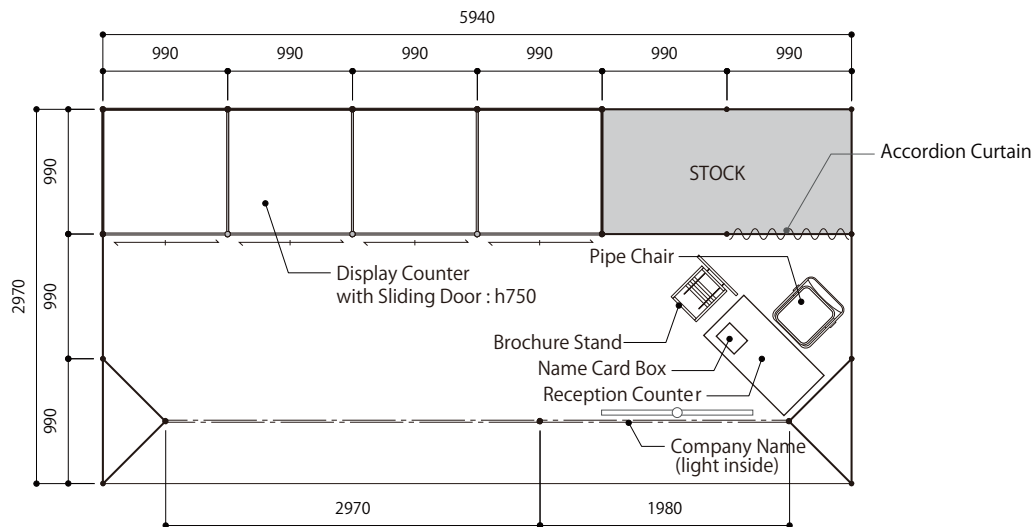

SCALE=1/60

Items	Qty.	Items	Qty.
Carpet	18m ²	Reception Counter (W900xD450xH800)	1
System Panel (W990xH3000)	2	Brochure Stand (A4 Vertical type 12 boxes)	1
Colored System Panel (W990xH3000)	4	Name Card Box	1
Parapet (acrylic) (H300)	1set	Pipe Chair	1
Company Name (with tape)	1set	Primary Electric Construction Fee (utility cost included)	1Kw
Colored Parapet	1set	Arm Light	1
Accordion Curtain	1set	Outlet (for 2 plugs)	1
Display Counter with Sliding Door (W990xD990xH750)	4		

※You may choose colors for the carpet, system panel and parapet.
Please refer to the Color Sample.

Standard Plan C (18m²)

■ Standard Plan C : 18m² Total JPY 346,500 (tax included)
Basic System Panel / Aluminum Truss

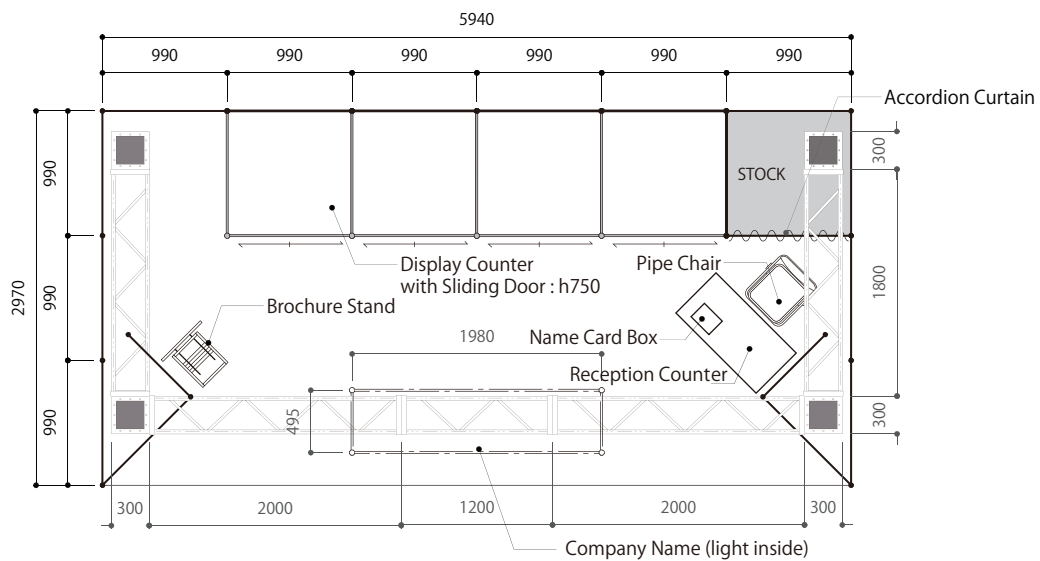
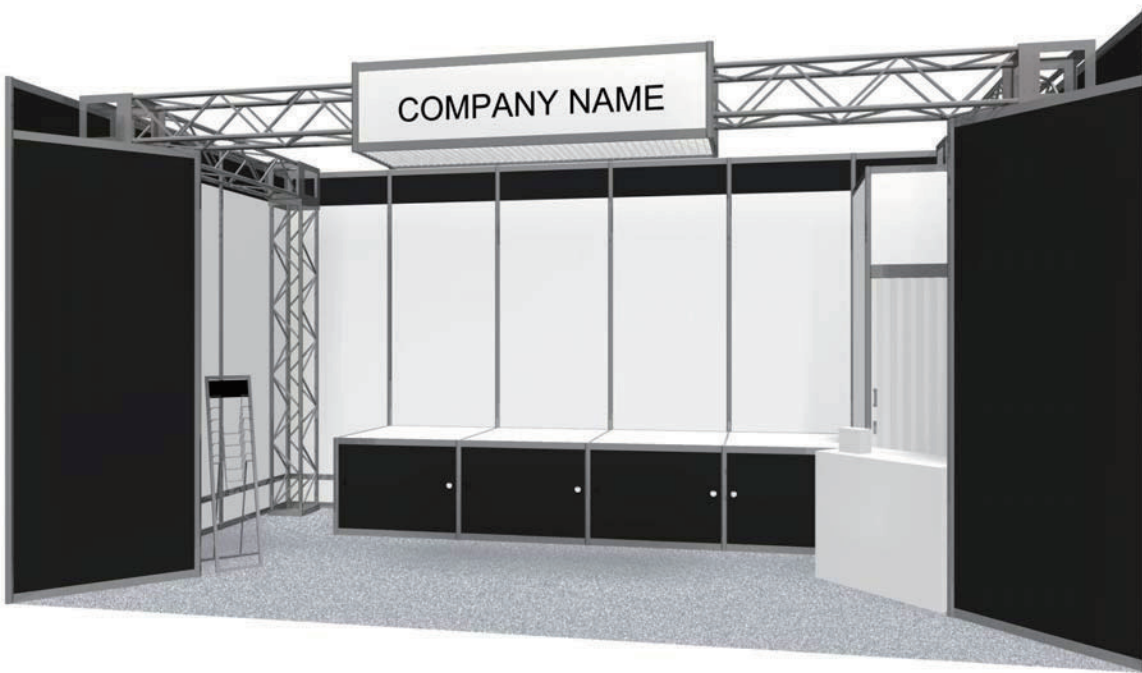

SCALE=1/60

Items	Qty.	Items	Qty.
Carpet	18 m ²	Reception Counter (W900xD450xH800)	1
Aluminum Truss	1set	Brochure Stand (A4 Vertical type 12 boxes)	1
System Panel (W990xH2700)	2	Name Card Box	1
Colored System Panel (W990xH2700)	4	Pipe Chair	1
Wall Color Sheets (H300)	1set	Primary Electric Construction Fee (utility cost included)	1Kw
Company Name (light inside)	1set	Arm Light	1
Accordion Curtain	1set	Outlet (for 2 plugs)	1
Display Counter (W990xD990xH750)	6		

※ You may choose colors for the carpet and system panel.
Please refer to the Color Sample.

Standard Plan D (27m²)

■ Standard Plan D : 27m² Total JPY 420,000 (tax included)
Basic System Panel / Aluminum Truss

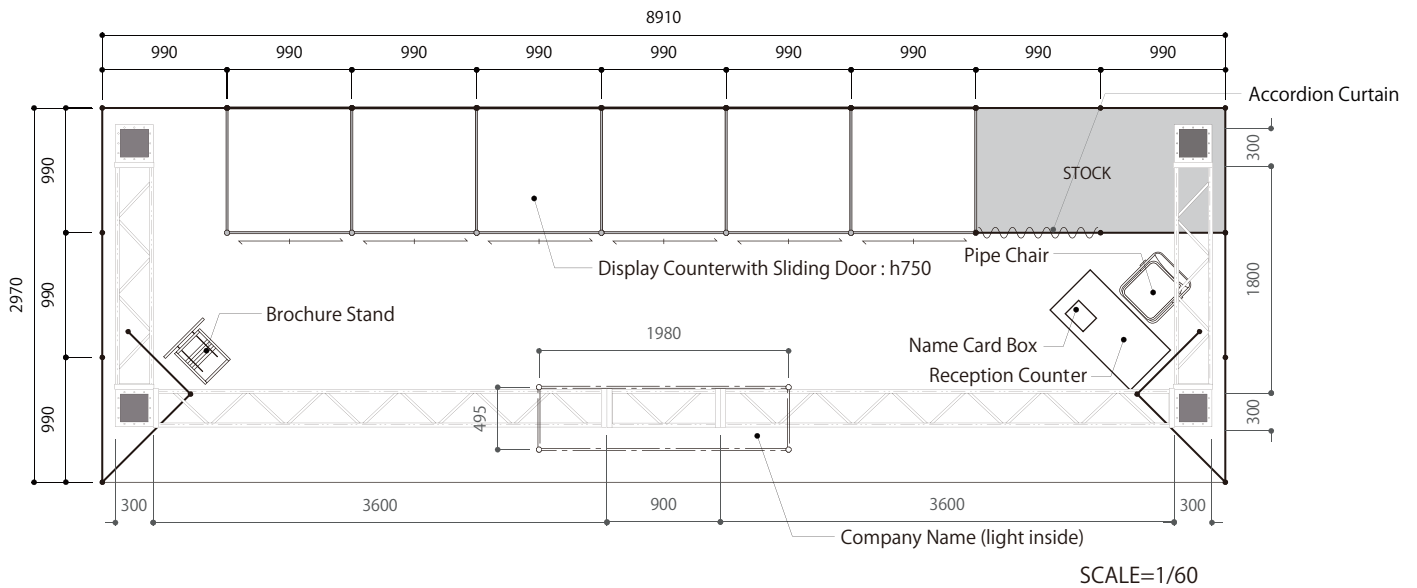
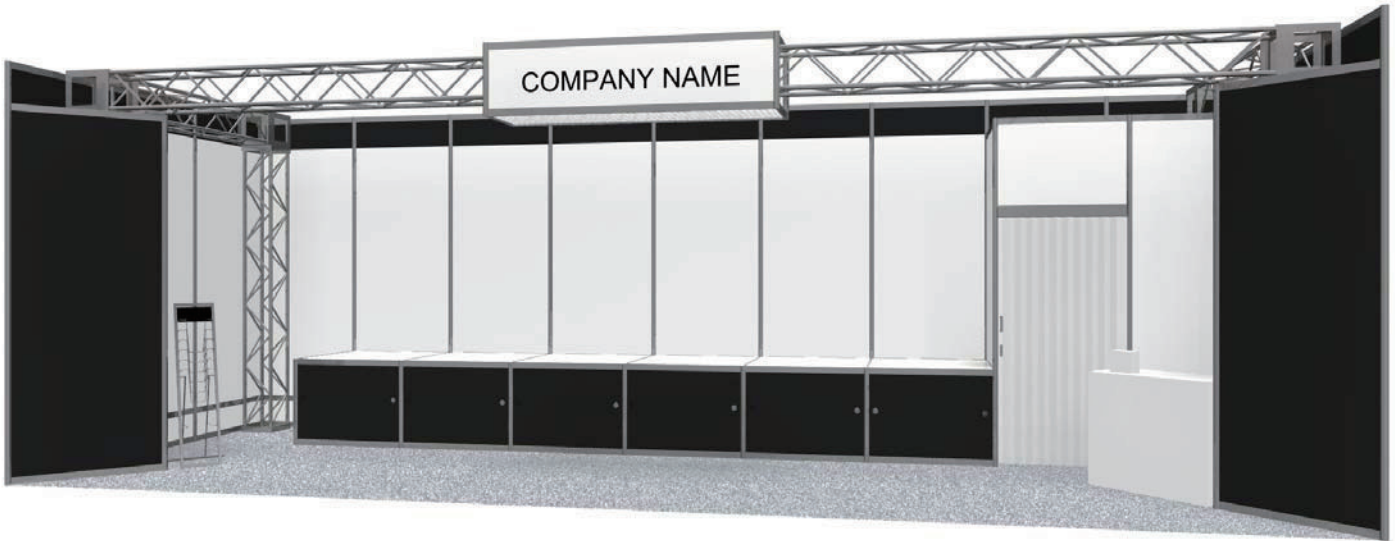

Items	Qty.	Items	Qty.
Carpet	18 m ²	Reception Counter (W900xD450xH800)	1
Aluminum Truss	1set	Brochure Stand (A4 Vertical type 12 boxes)	1
System Panel(W990xH2700)	2	Name Card Box	1
Colored System Panel (W990xH2700)	4	Pipe Chair	1
Wall Color Sheets (H300)	1set	Primary Electric Construction Fee (utility cost included)	1Kw
Company Name (light inside)	1set	Arm Light	2
Accordion Curtain	1set	Outlet (for 2 plugs)	1
Display Counter with Sliding Door (W990xD990xH750)	6		

※You may choose colors for the carpet and system panel.
Please refer to the Color Sample.

COLOR SAMPLE

CARPET COLOR

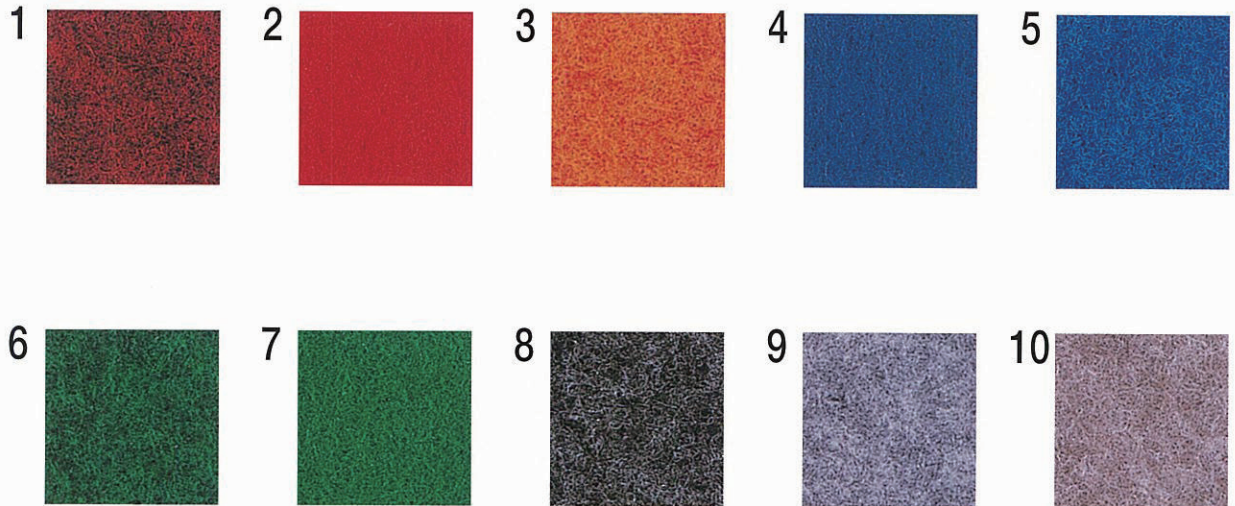

WALL / PARAPET COLOR

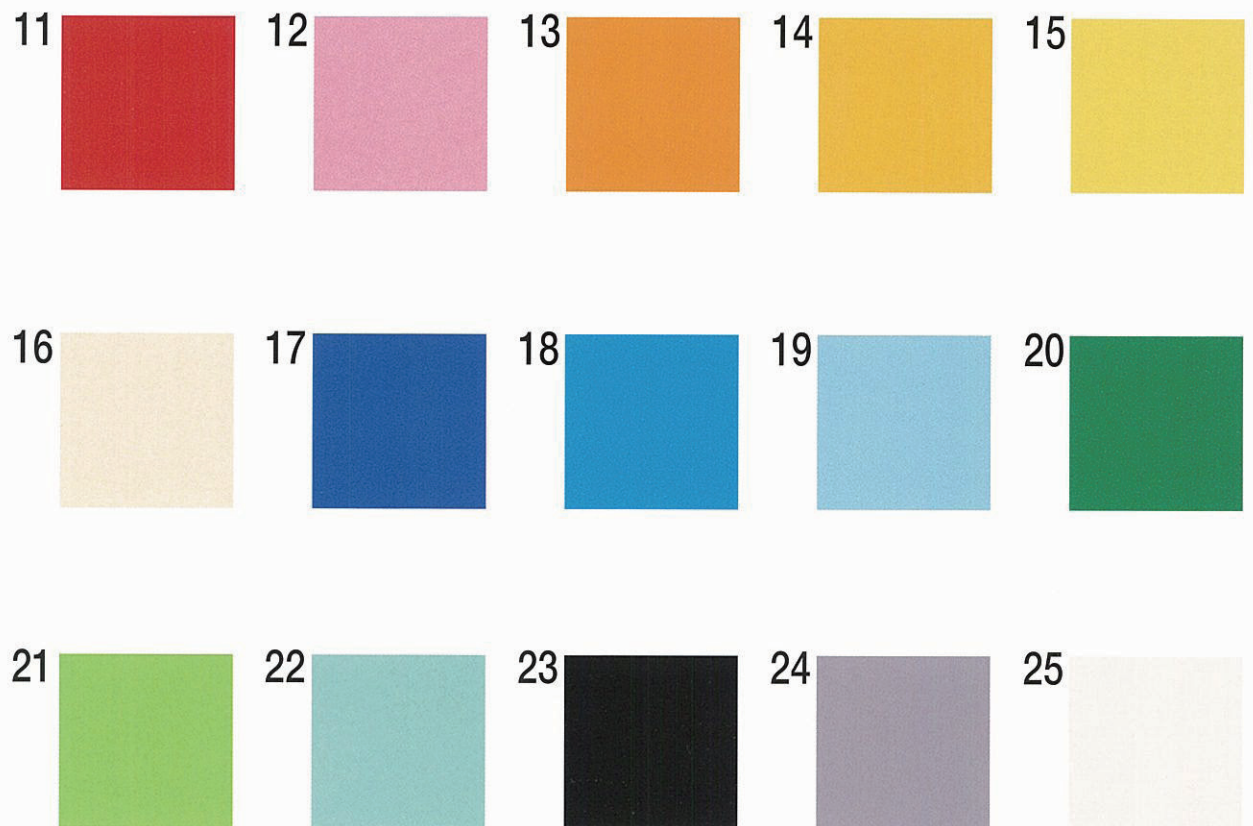

■ Colors may be seen differently from printing image